

www.luxalon.com

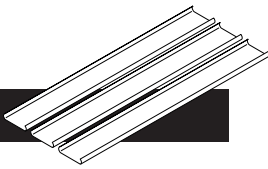



SYSTEM OVERVIEW
75-150-225C EXTERIOR SYSTEM

SHORT SYSTEM DESCRIPTION

The Luxalon® Exterior Closed Ceiling System has a choice of three widths of panels (1). This Luxalon® exterior ceiling is unique for its bevelled edges and for the closed smooth appearance. All three widths can be combined and easily clipped on a universal carrier (2). The 0.6 mm thick stove enamelled aluminium panels are recyclable, lightweight and strong. The panels are made to measure and can be supplied in any length up to 6000 mm. Panels can be joined by using the panel splice (5).

Locking clips (6) for 150C and 225C are fitted crosswise on to the carrier, on top of the prongue in order to fully secure the panels and to create a ceiling able to withstand windloads.

The panel carrier (2) is black, made of 0.95 mm thick stove enamelled aluminium and is provided with prongs to accommodate the panels in a width of 75, 150 or 225 mm. Carriers have a standard length of 5000 mm and are connected by using the carrier splice (4). The carriers can be suspended at centres determined by the wind loading graphs (see opposite page) using a rigid levelled suspension system. Utilising the washer set to isolate dissimilar metals.

PRACTICAL APPLICATIONS

- The neat closed joints present a smooth uninterrupted appearance.
- Panel length made to measure up to 6000 mm, allowing swift installation and reducing the need for panel joints.
- Panels are fixed to the carrier by locking clips, providing a rigid system which is able to withstand wind pressure and suction.
- Panels are made from a corrosion resistant aluminium alloy.
- The panels can be easily removed and replaced by using a dismantling tool allowing easy and full access to services and installations in the plenum, even in combination with the locking clips (see detail B).
- By combining the narrow and wide panels (75, 150 and 225 mm) on one universal carrier, various dimensional effects are possible, providing the designer unlimited possibilities.

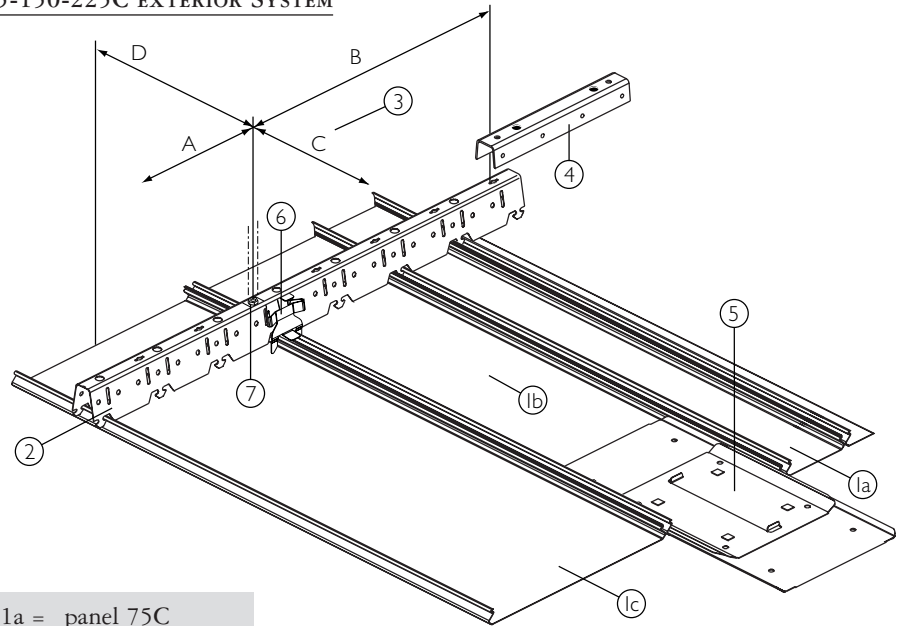

- 1a = panel 75C
- 1b = panel 150C
- 1c = panel 225C
- 2 = carrier
- 3 = non Luxalon® rigid suspension
- 4 = carrier splice
- 5 = panel splice
- 6 = locking clip
- 7 = washer set

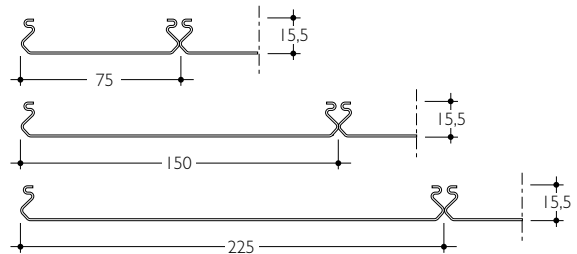

DIMENSIONS & WEIGHTS

Panel	Modul	Min. Length	Max. Length	Weight panels & carrier/m ² *
75C	75	1000	6000	2.63 kg
150C	150	1000	6000	2.29 kg
225C	225	1000	6000	2.28 kg

* Based on panels installed on 4 or more carriers with an average windload of 1000 N/m². Panels from 250-1000 mm and >6000 mm are available on request.

STANDARD CONSTRUCTION DETAILS

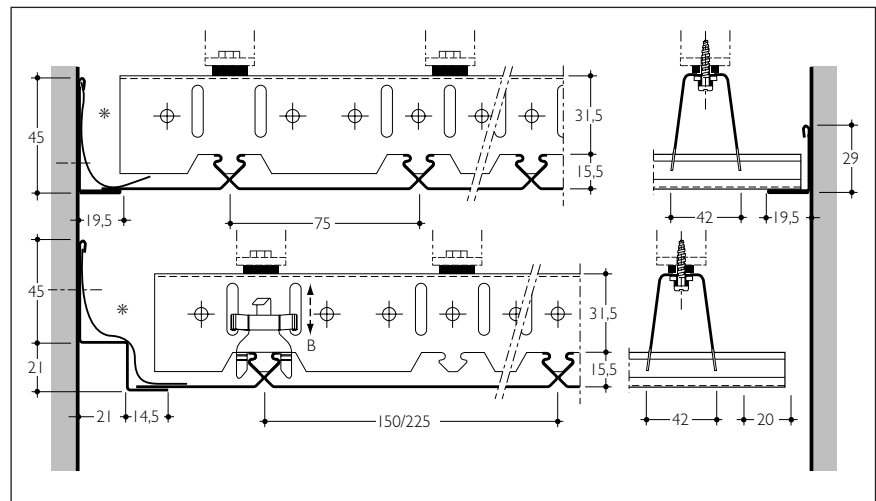

MATERIAL REQUIREMENTS PER M²

	Unit	75C	150C	225C
Panels	lm	13.33	6.67	4.44
Carriers	lm	1.09	1.33	1.97
Carrier splice	pcs	0.22	0.27	0.39

Edge profiles and other accessories depend on individual project requirements.

Figures are based on panels installed on 2 or 3 carriers on maximum spans at an average windload of 1000 N/m².

EDGE PROFILES

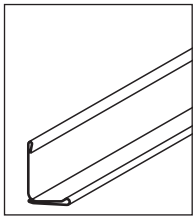

Wall L-profile Alu
(29.2 x 19.4)

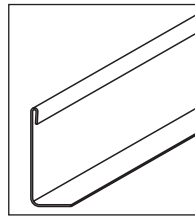

Wall L-profile Alu
(45 x 18.5)

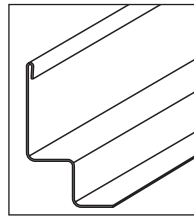

Wall W-profile Alu
(45 x 21 x 21 x 18.5)

PLENUM ACCESSIBILITY

The Luxalon® exterior closed ceiling system allows for easy demounting of the panels. Installed on a visually hidden suspension system, each panel can be easily removed by using a special dismounting tool which can be put into a standard utility-knife (stanley-knife), allowing easy and full access to services and installations in the plenum.

MAXIMUM SPANS

Panel type	Carrier span (mm)		Panel Span (mm)			
	A	B	on 2 carriers		on 3 or more carriers	
			C	D	C	D
75C-150C-225C	300	See graph next page	See graph next page	150	See graph next page	150

- PANEL SPANS (C)

From the graph next page, panel spans in relation to windloads can be calculated (pressure or suction).

- CARRIER SPANS (B)

Before establishing the carrier span (screw distance), the load per lineal meter of carrier has to be determined by applying one of the next formulas:

Panels installed on:	Calculation of 'load per lineal meter carrier'
2 carriers	0.5 q x panel span (C) in m
3 carriers	1.25 q x panel span (C) in m
4 or more carriers	1.15 q x panel span (C) in m

q = windload in N/m² (uniformly distributed loads)

The carrier span (screw distance) (B) can be read from the adjacent graph.

These Exterior Closed Ceilings were tested by a Dutch independent official testing institute, reports: 2000 BT-BK-RO54

Note 1: the indicated values are all based on the use of locking clips for 150C + 225C (75C can be installed without locking clips)

Note 2: The actual dynamic windload shall be determined with due consideration to the relevant local Standard Codes of Building Practice.

MATERIAL SPECIFICATIONS

- BASE MATERIAL

Luxalon® Exterior Closed Ceiling panels are rollformed from 0.6 mm thick prepainted stove enamelled aluminium strip. All aluminium products can be recycled for the full 100% requiring very little energy.

- COATING

The tough and durable standard finish in a nominal thickness of approximately 20 microns, is stove enamelled in a continuous coil-coating process ensuring a uniform coating. The Luxacote® finish guarantees optimum adhesion and excellent resistance to weathering.

- LUXALON® COLOUR RANGE

The standard Luxalon® colour range for closed exterior ceilings includes different colours and finishes. See Luxalon® exterior colour chart. Any other (RAL or NCS) colour is available on request.

PANEL SPANS 75C CLOSED CEILING

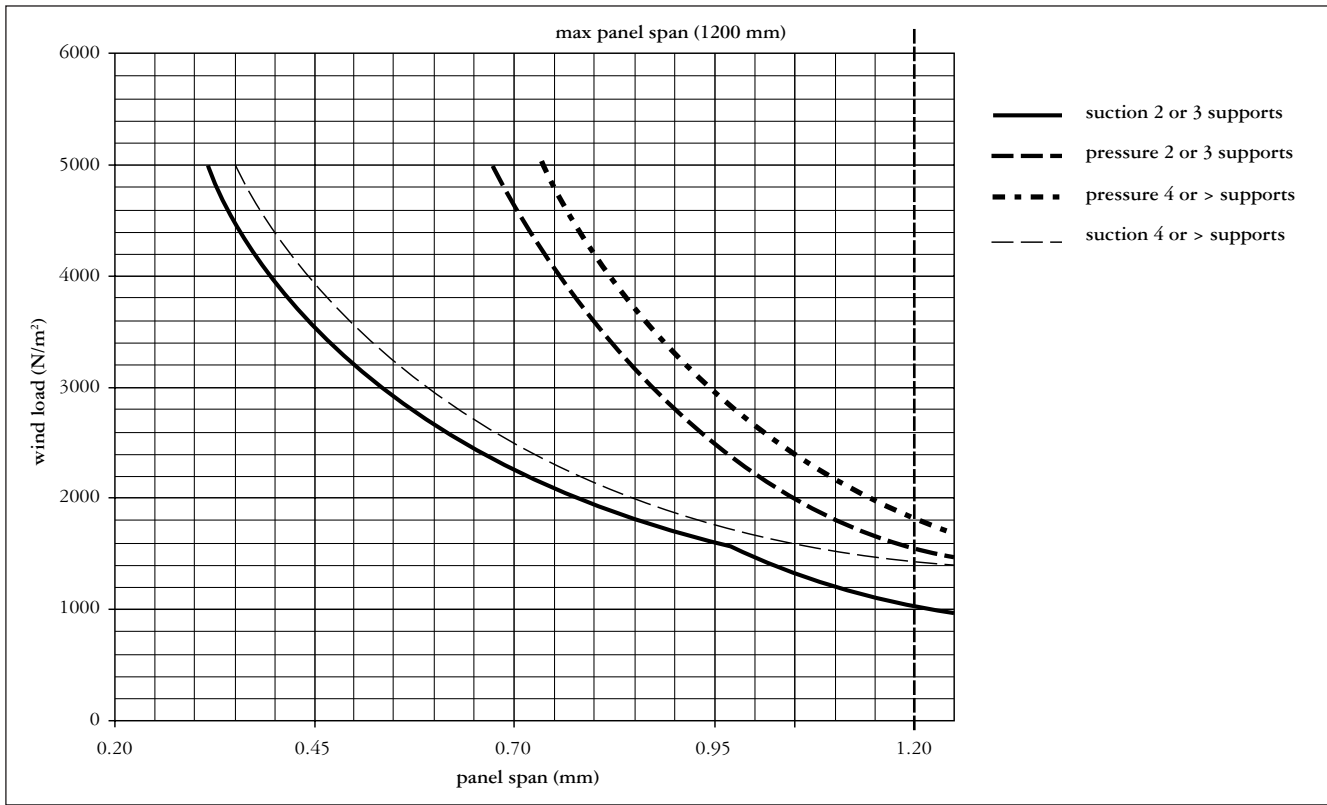

PANEL SPANS 150C CLOSED CEILING WITH CLIPS

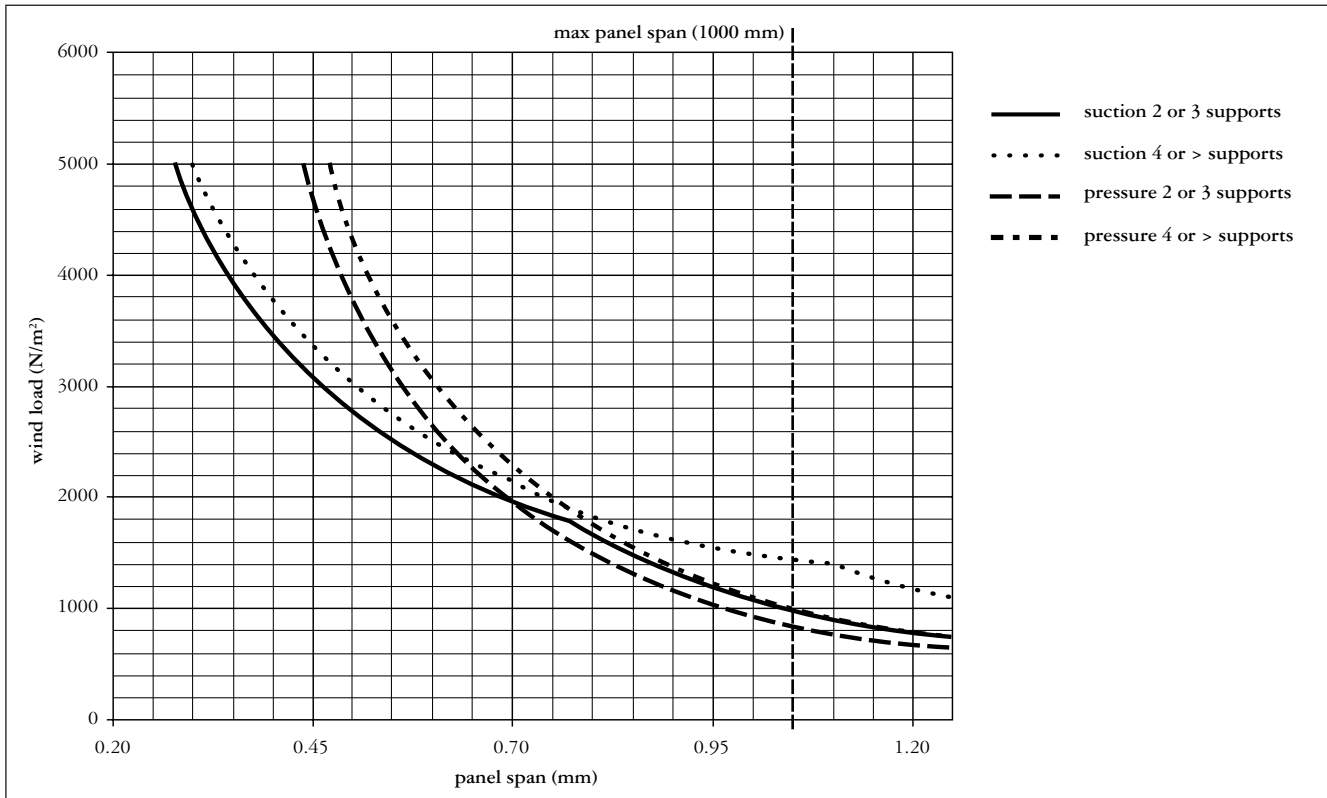

PANEL SPANS 225C CLOSED CEILING WITH LOCKING CLIPS

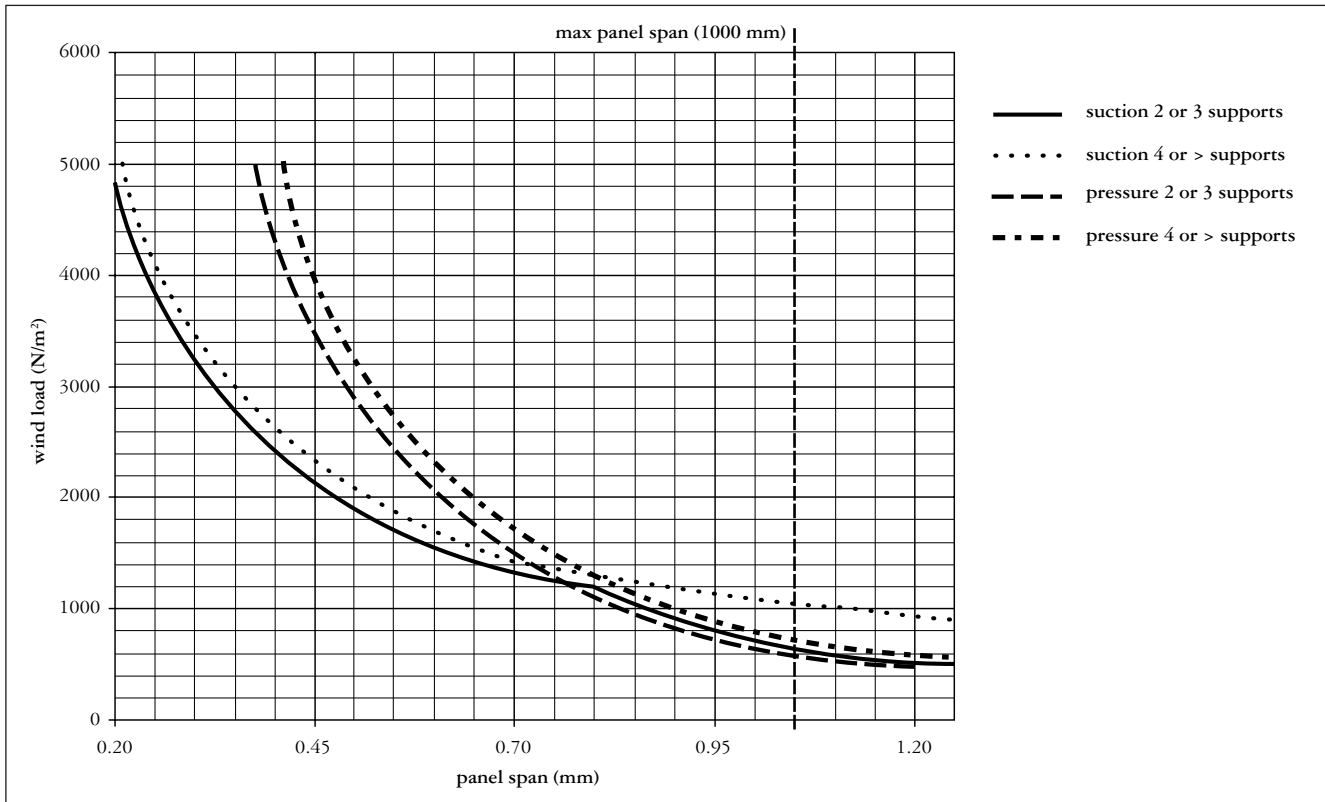

CARRIER SPANS 75C/150C/225C CLOSED CEILING

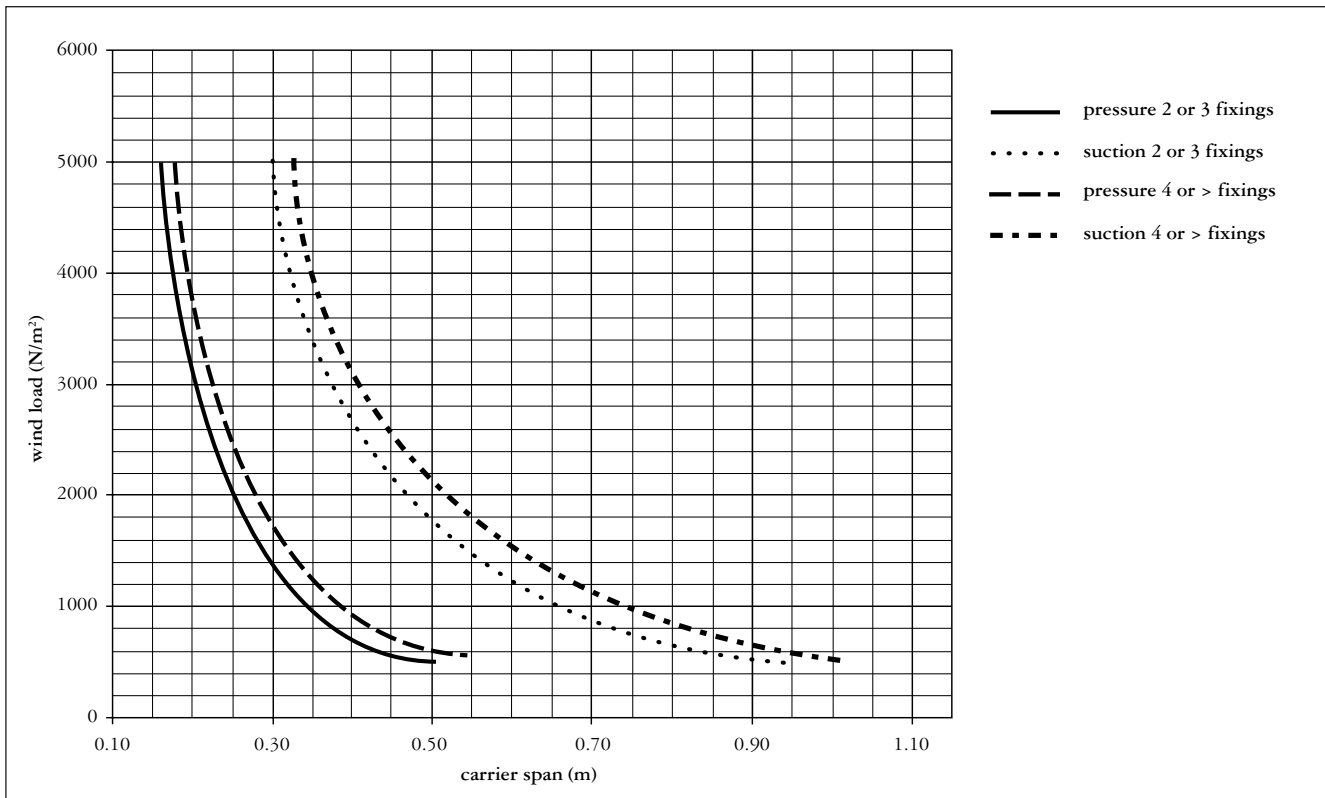

LUXALON® EXTERIOR CLOSED CEILING SYSTEM SPECIFICATION

PART 1. EXTERIOR CLOSED CEILING SYSTEM GENERAL

1.1 INTRODUCTION

Supply and fix Luxalon® exterior closed ceiling system as manufactured by Hunter Douglas Architectural Products.

1.2 DESCRIPTION OF THE SYSTEM

The system will consist of linear panels fixed to an adjustable suspension system, in combination with locking clips, which allows for individual panels to be removed by using a dismantling tool. Panels of different widths can be combined in the ceiling, if desired. To prevent contact corrosion by applying dissimilar metals, each fixing of the carriers to the subconstruction must be made through the Luxalon® washer set.

PART 2. PRODUCT

_____ m² Luxalon® Exterior Closed Ceiling, consisting of:

2.1 PANELS

- 75C, size 75 x 15,5 mm, to be manufactured from 0.6 mm Aluminium.
- 150C, size 150 x 15,5 mm, to be manufactured from 0.6 mm Aluminium.
- 225C, size 225 x 15,5 mm, to be manufactured from 0.6 mm Aluminium.

Panels to be manufactured from prepainted, stove enamelled aluminium, corrosion resistant alloy EN-AW-3005 or equivalent (according to EN 1396 and ECCA). Panels have a length of _____ mm (manufacturer availability 1000-6000 mm and on request 250-1000 mm and > 6000 mm). Panels to be coupled in longitudinal direction by means of panel splices.

2.2 SUSPENSION

Rows of 0.95 Alu rollformed carriers shall be installed at _____ centre on centre by means of a levelled suspension of sufficient strength and rigidity to provide resistance to windpressure/windsuction, at a distance of _____, centre on centre. Carriers will be joined by means of carrier splices. Carriers provided with prongs to hold panels in a module which is a multiple of 75 mm. Panels are locked to the carrier by crosswise installed separate locking clips.

PART 3. ADDITIONAL SPECIFICATIONS

3.1 PERIMETER PROFILES

- Wall L-profile 29.2 x 19.4 mm made of 0.5 mm thick aluminium
- Wall L-profile 45 x 18.5 mm made of 0.8 mm thick aluminium
- Wall W-profile 45 x 21 x 21 x 18.5 mm made of 0.8 mm thick aluminium

3.2 COATING

Architect will make a colour selection from the standard Hunter Douglas colour range for Luxalon® exterior 75/150/225C panels code no. _____ or a special colour will be made to match.

The coating will consist of the tough and durable Luxacote® finish in nominal thickness of approximately 20 microns, applied in a continuous coilcoating process ensuring uniform coating thickness. The Luxacote® finish guarantees optimum adhesion and excellent resistance to weathering.

3.3 INSTALLATION

All materials shall be installed in strict compliance with all local codes, ordinances and manufacturers recommendations including specific additional requirements as may be called for in the specifications or shown on the drawings.



LUXALON®
ARCHITECTURAL PRODUCTS

HUNTER DOUGLAS EUROPE B.V.

2, Piekstraat - P.O. Box 5072 - 3008 AB Rotterdam - Tel. 010-4869911 - Fax 010-4847910 - www.luxalon.com

© Registered trademark - a HunterDouglas® product Pats. & Pats. Pend. - Technical data subject to change without notice. MX291Q00
© Copyright Hunter Douglas 2004. No rights can be derived from copy, text pertaining to illustrations or samples. Subject to changes in materials, parts, compositions, designs, versions, colours etc., even without notice.

