

# Monteringsanvisning Stripe

Konstruktion - Line3000 - LED

## Systemdetaljer

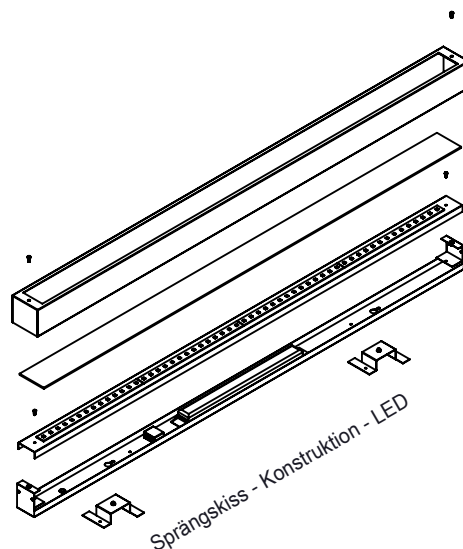
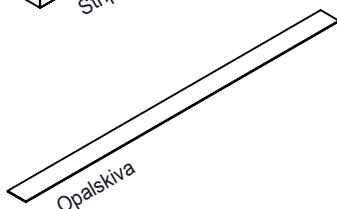
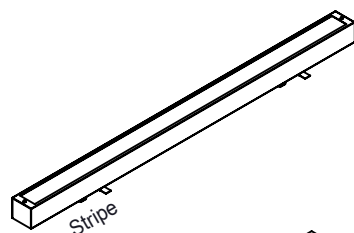
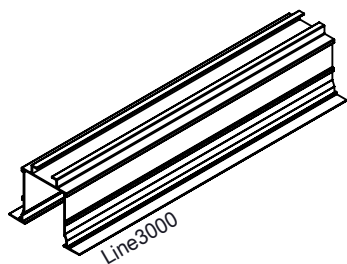

## Montage

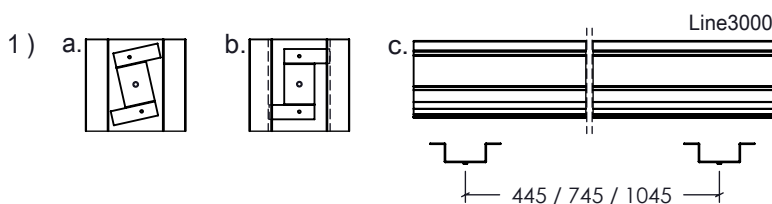

Vrid in och montera distanserna:  
c/c 445mm. - STR9-T5/LED  
c/c 745mm. - STR12-T5/LED  
c/c 1045mm. - STR15-T5/LED  
(Montageskruv medföljer ej)

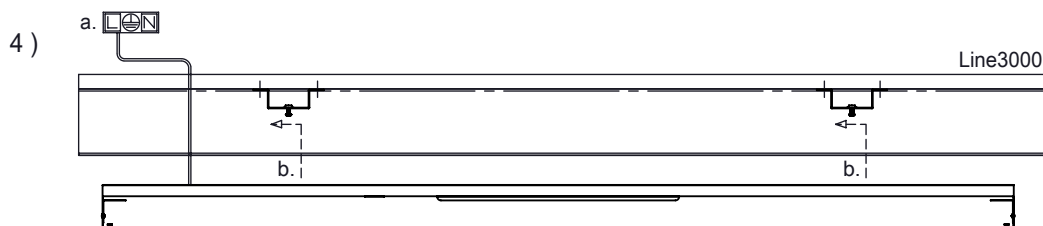
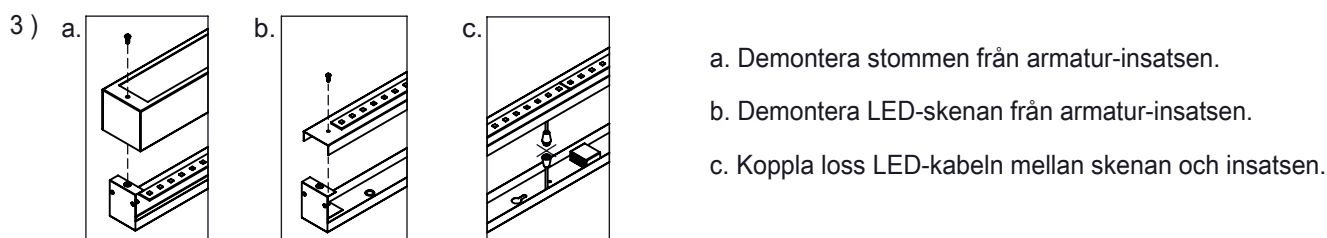
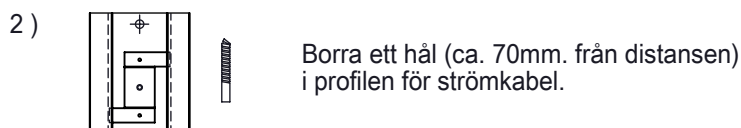

a. Förse insatsen med strömkabel.  
b. Haka i insatsen på distanserna via nyckelhålen och fixera.

Fortsätter på nästa sida.

# Monteringsanvisning Stripe

Konstruktion - Line3000 - LED

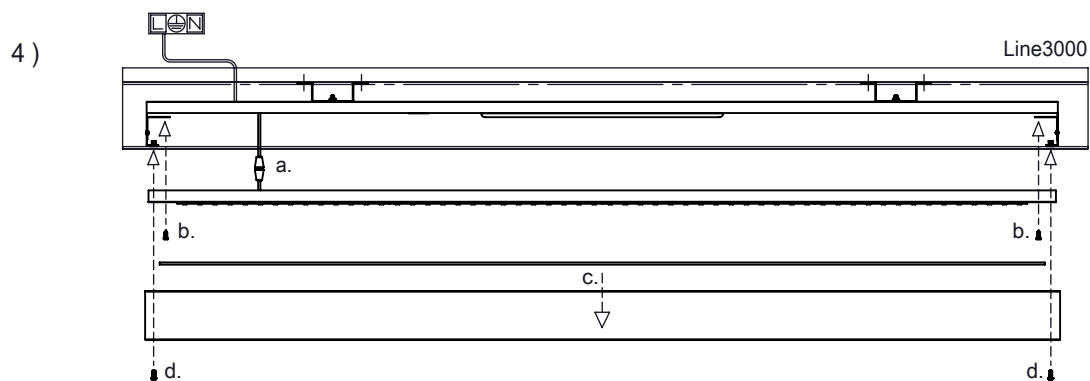

- a. Koppla ihop LED-kabeln mellan skenan och insatsen.
- b. Montera LED-skenan.
- c. Läg opalskivan i stommen.
- d. Montera tillbaka stommen på armatur-insatsen.

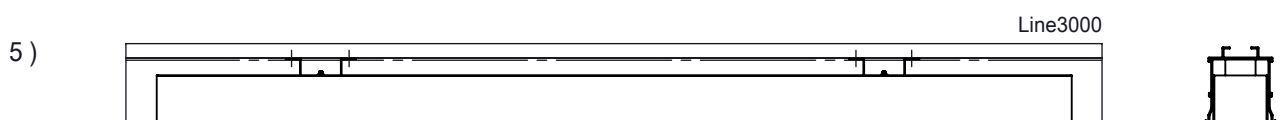

Klart!

- Bygghöjd

