

SYSTEMINFO

KONSTRUKTION

Bärprofiler diktmonteras eller pendlas ned från bjälklag. Pendlat montage sker alltid med stumma pendlar.

KASSETTER

Modultak med 20 mm. springa runtom.

Kassett monteras underifrån med två st. byglar som hakas i bärprofilens anpassade spår.

Längd: Max. 2200 mm.
Bredd: Std. 580 mm. (=Modul 600)

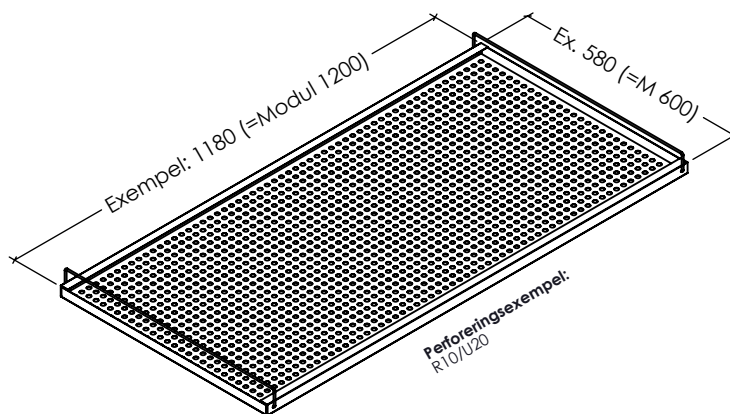

ANSLUTNINGAR / SYSTEMHÖJD

Se sid. 2

MONTERING / FUNKTION

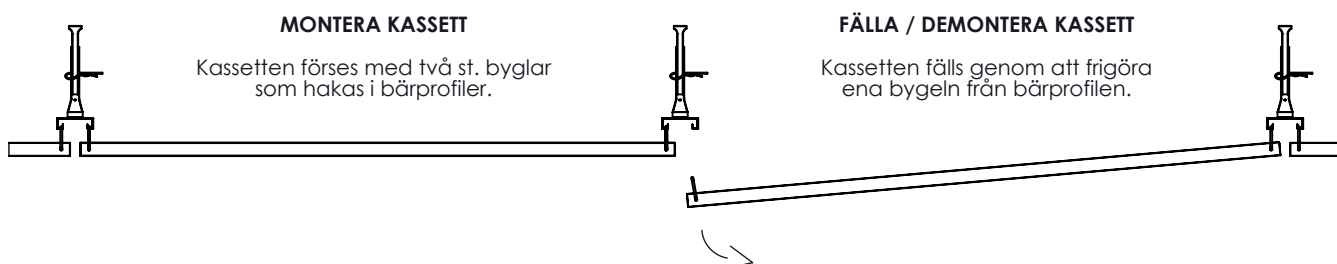

SYSTEMDETALJER

Hakprofil U (9676)
Längd: 2400

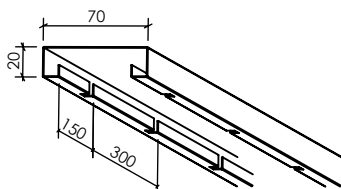

Hakprofil ULS (9577)
Längd: 2400

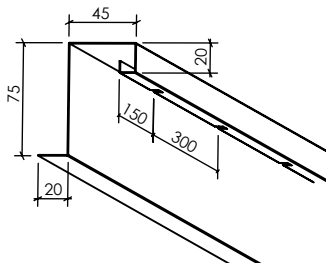

Hakprofil ULFS (9677)
Längd: 2400

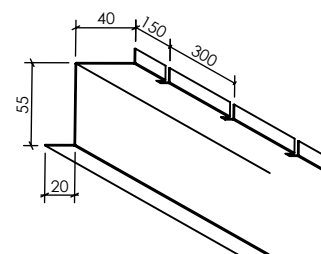

Hakprofil K (9667)
Längd: 2400

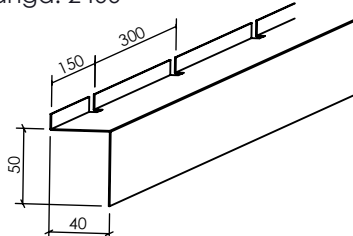

Hakprofil V (9679)
Längd: 2400

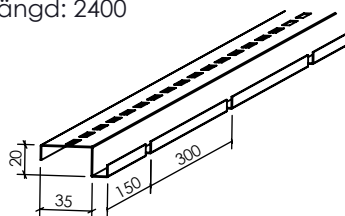

Hakprofil VU (9670)
Längd: 2400

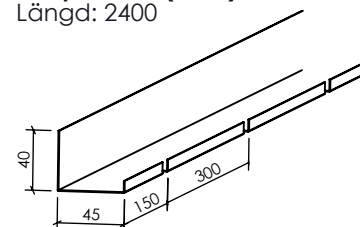

Bärok/skarv (9676-BSK)

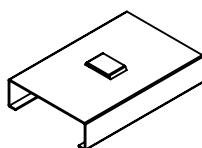

Bärok/skarv (9577-BSK)

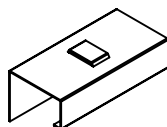

Skarv (9679)

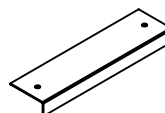

Konsol (9680)

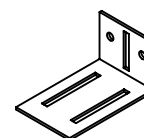

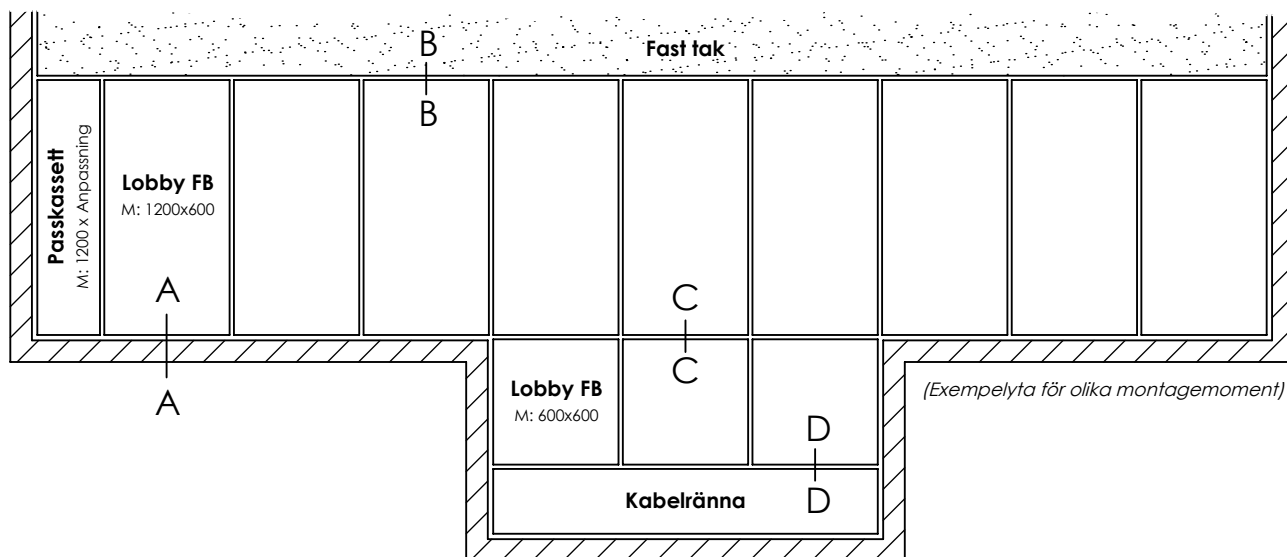

A-A) AVSLUT MOT VÄGG

Hakprofil V (9679) + Konsol (9680)

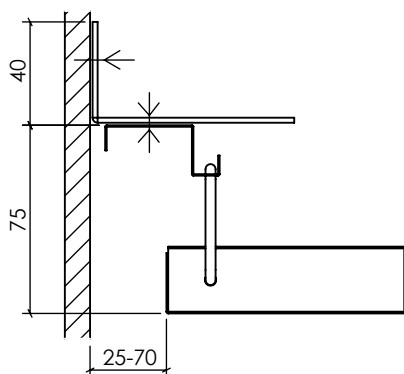

A-A) AVSLUT MOT VÄGG (alt. 2)

Hakprofil VU (9670)

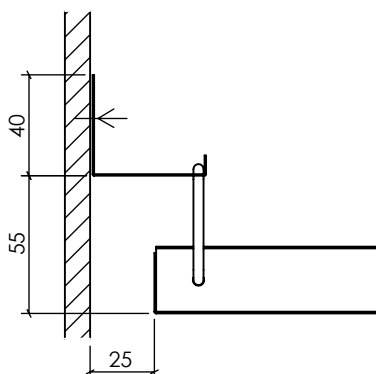

B-B) ANSLUT MOT FAST TAK

Hakprofil ULS (9577)

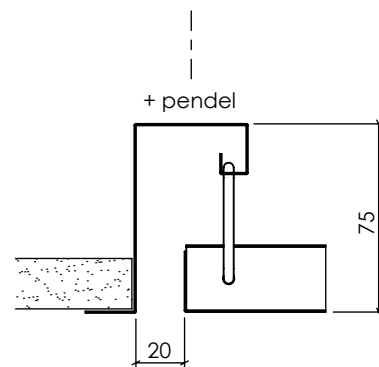

C-C) DUBBELUPPHÄNGNING

Hakprofil U (9676)

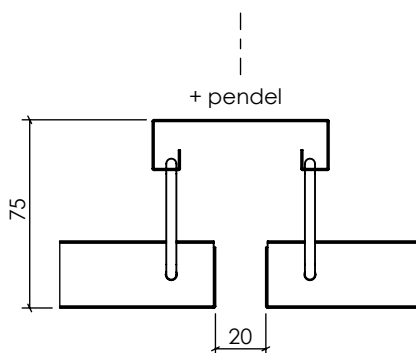

D-D) ANSLUT MOT KABELRÄNNA

Hakprofil K (9667)

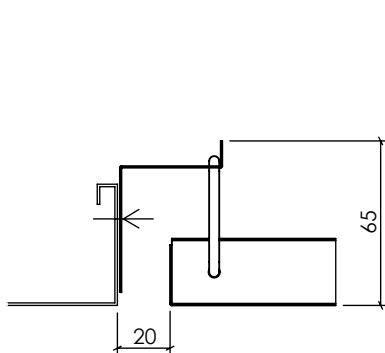

REKOMMENDERAD PENDEL

Nonius

