

Monteringsanvisning Stripe

Konstruktion - Line3000 - T5

Systemdetaljer

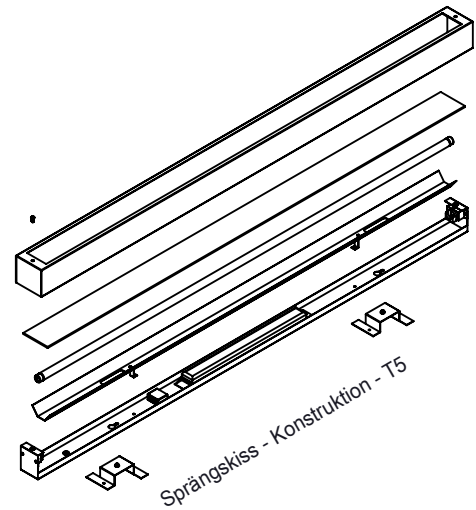
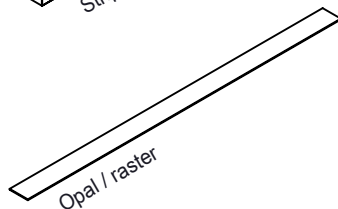
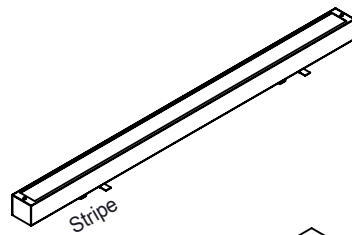
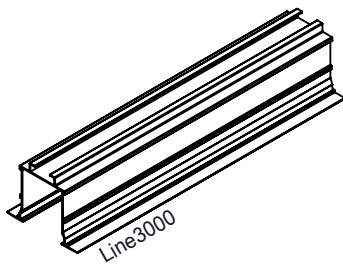

Montage

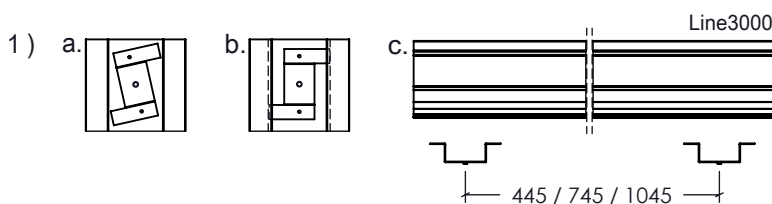

Vrid in och montera distanserna:
c/c 445mm. - STR9-T5/LED
c/c 745mm. - STR12-T5/LED
c/c 1045mm. - STR15-T5/LED
(Montageskruv medföljer ej)

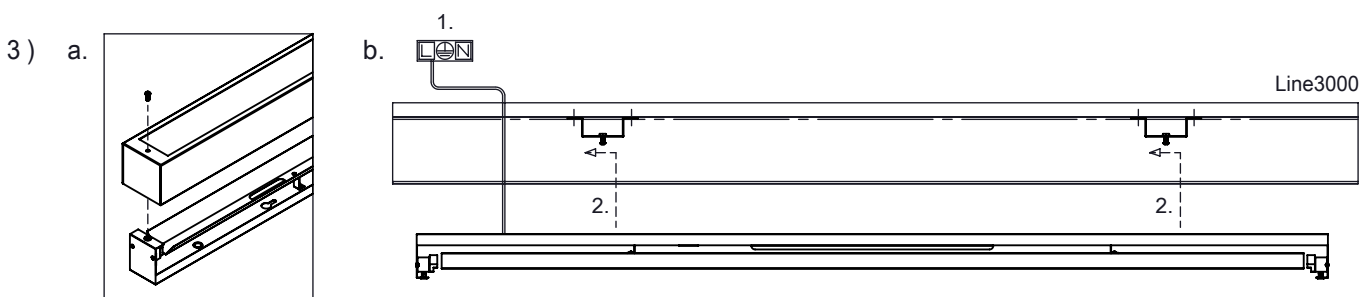
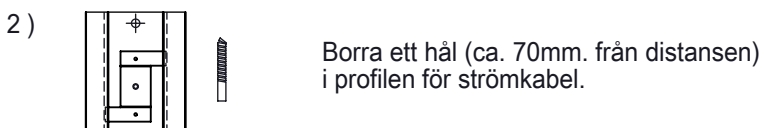

a. Demontera stammen från armatur-insatsen.

b-1. Förse insatsen med strömkabel.

b-2. Haka i insatsen på distanserna via nyckelhålen och fixera.

Fortsätter på nästa sida.

Monteringsanvisning Stripe

Konstruktion - Line3000 - T5

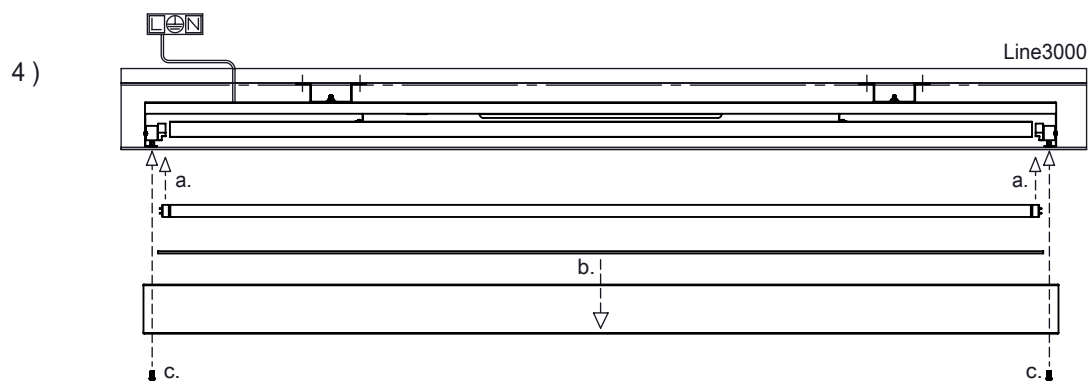

- a. Montera lysrör.
- b. Lägg opalskivan / rastret i stommen.
- c. Montera tillbaka stommen på armatur-insatsen.

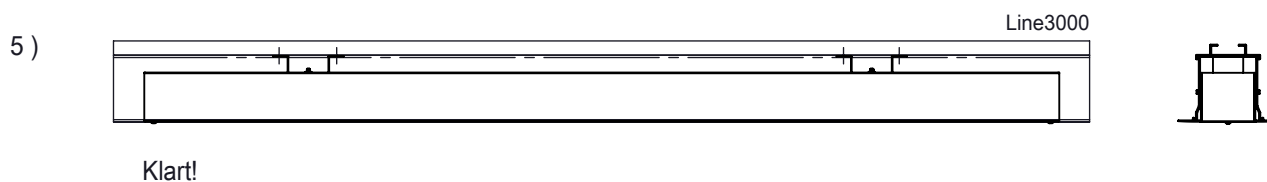

- Bygghöjd

